

***First direct observation of positron capture process at
the positron source of the SuperKEKB B-Factory***

Tsuyoshi Suwada (tsuyoshi.suwada@kek.jp)
Accelerator Laboratory, KEK,
and the Graduate University for Advanced Study,
SOKENDAI

Introduction

- ✓ In 2020, the positron (e^+) source of the *SuperKEKB (SKEKB) B-Factory* was upgraded to increase the positron yield.
 - *Countermeasure against electric discharge for the AMD, installations of steering magnets, and beam diagnostics.*
- ✓ There are three difficulties to install any beam diagnostics,
 - *in radiation hard environment, almost no space to install them, and difficult technique to simultaneously and separately detect both secondary e^- and e^+ bunches with very short time interval.*
- ✓ A wideband beam monitors (WBMs) were successfully installed in the e^+ source.
- ✓ In this report, the motivation for introducing WBMs, and their detection technique, and some results are presented.

The SuperKEKB B-Factory: an electron-positron collider with asymmetric energies

$e^+ E = 4 \text{ GeV}$

$e^- E = 7 \text{ GeV}$

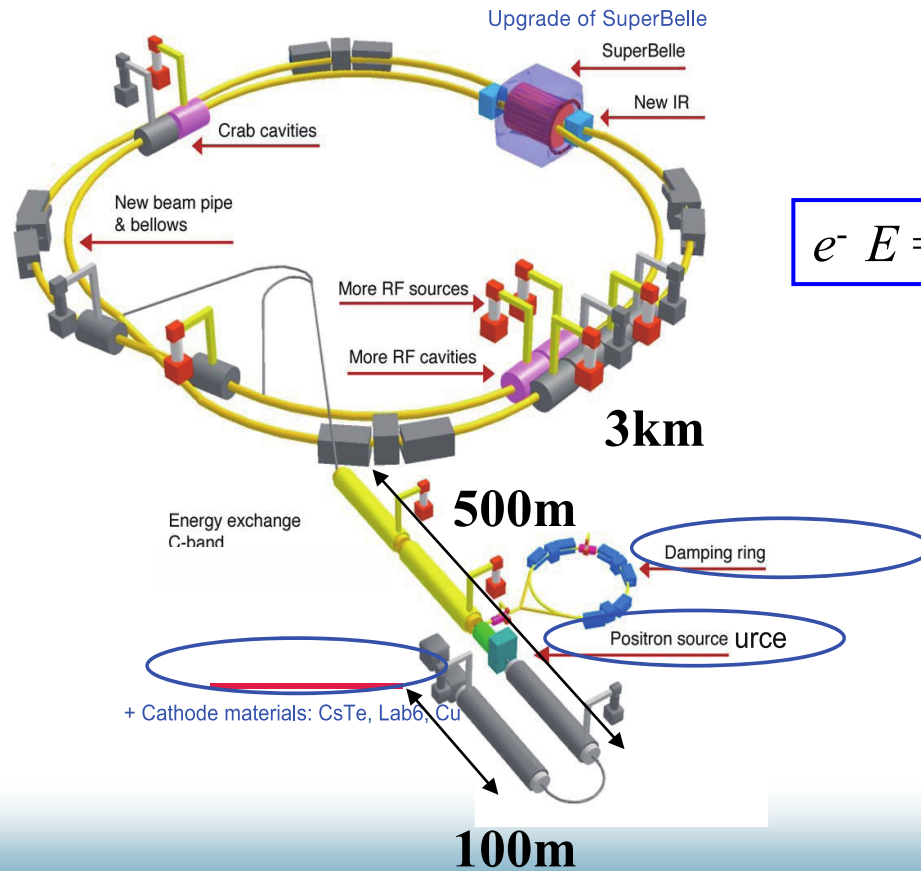

The SKEKB e^+ source

(a) Positron source

SLs 0.4T, Acc.G 14-20 MV/m@unit1-5
SLs 0.5T, Acc.G 10 MV/m @unit1-6

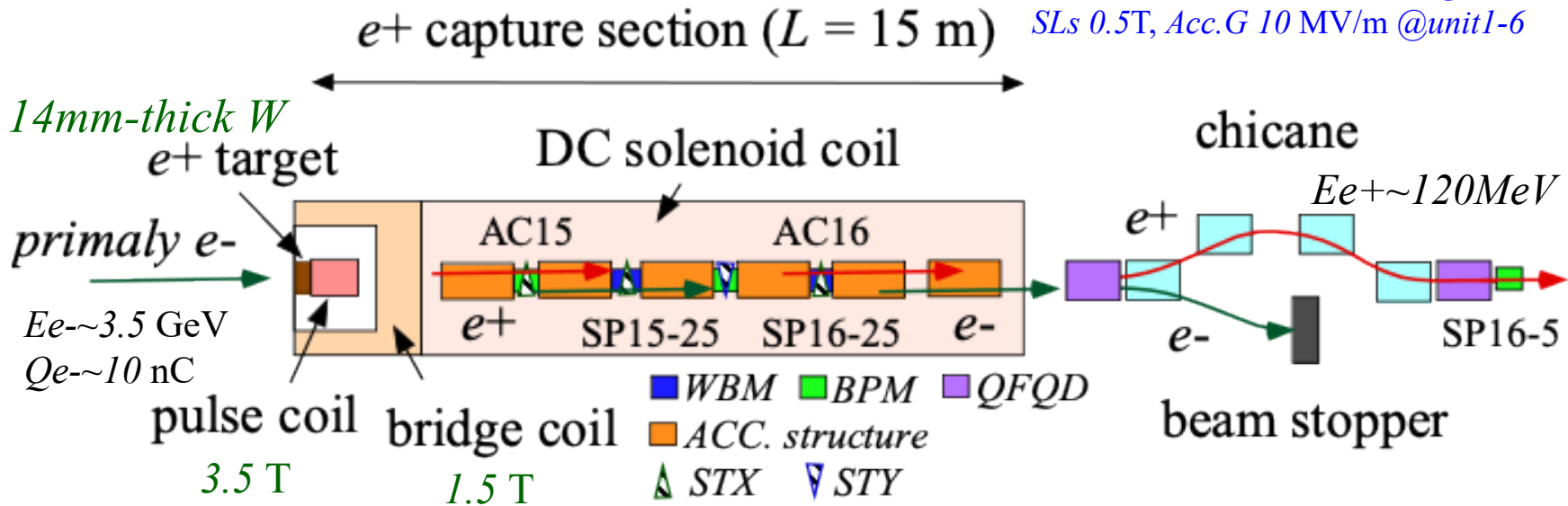

1. Secondary e^+e^- bunches are immediately captured in the transverse phase space by applying strong pulsed and DC magnetic fields. On the other hand, in the longitudinal direction they are captured by applying electromagnetic fields in accelerating structures. The e^- bunch is stopped by a beam stopper at a chicane and the e^+ bunch passes through it. The bunch charges are first measured by a standard BPM after the chicane.

2. One of the important issues for beam diagnostics is to simultaneously and separately detect parallel travelling e^+e^- bunches with very short distances by two WBMs in the capture section.

- How can we detect simultaneously and separately these secondary e^- and e^+ bunches?
- Which detection technique is suitable, in time domain or frequency domain?
- What kinds of bunch characteristics for a single bunch are measurable?

Historical detection technique in time domain at the SLC e^+ sources

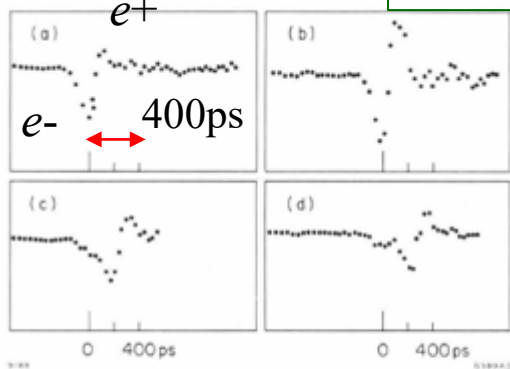
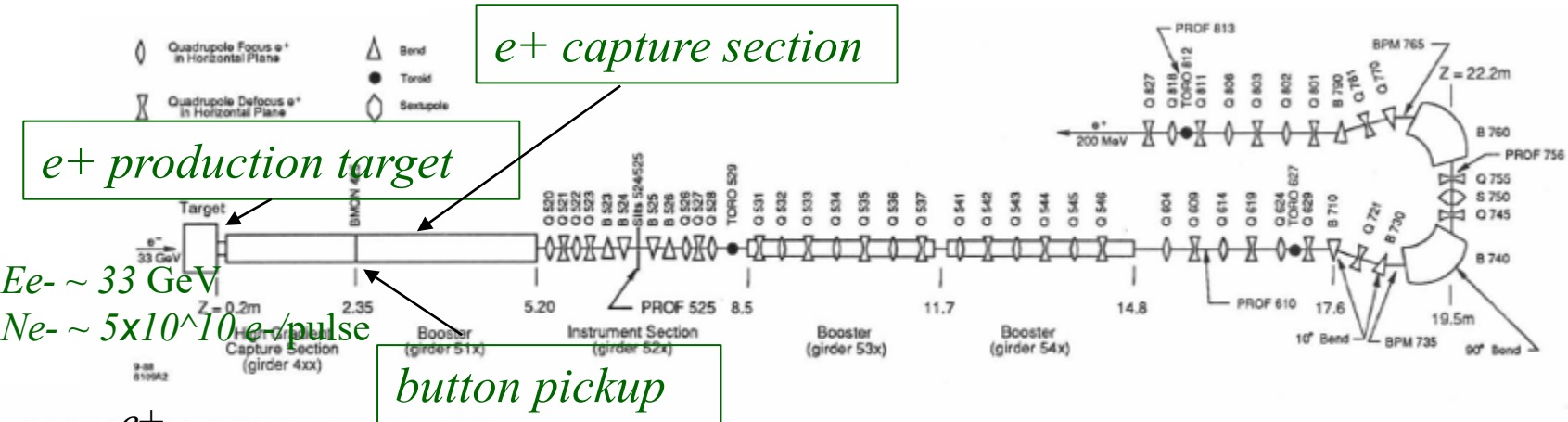

Fig. 3. Initial button monitor (BMON 425) signal: a) capture section off; b) capture RF phased (108°) for large leading negative pulse; and c) signal when RF phased about 180° away, viz., at -64° and d) at -94° .

fig. 2. Positron capture and booster transport system.

1. Referred by J. E. Clendenin, et al., "SLC positron source startup"; Procs. of 1988 Linear Accelerator Conf, Williamsburg, Virginia, USA.
2. The commissioning of the e^+ source began in early September of 1986.

We can barely recognize both e^- and e^+ bunches, for which the signals were obtained by a button pickup. The bunch separation is not very good in time domain.

Historical detection technique in frequency domain

e^+ production target at the APS e^+ sources

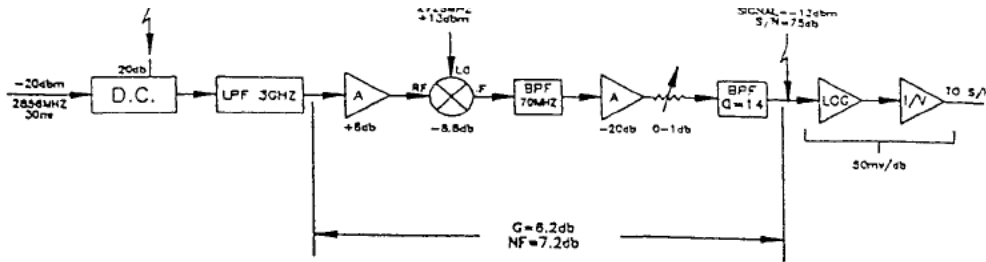
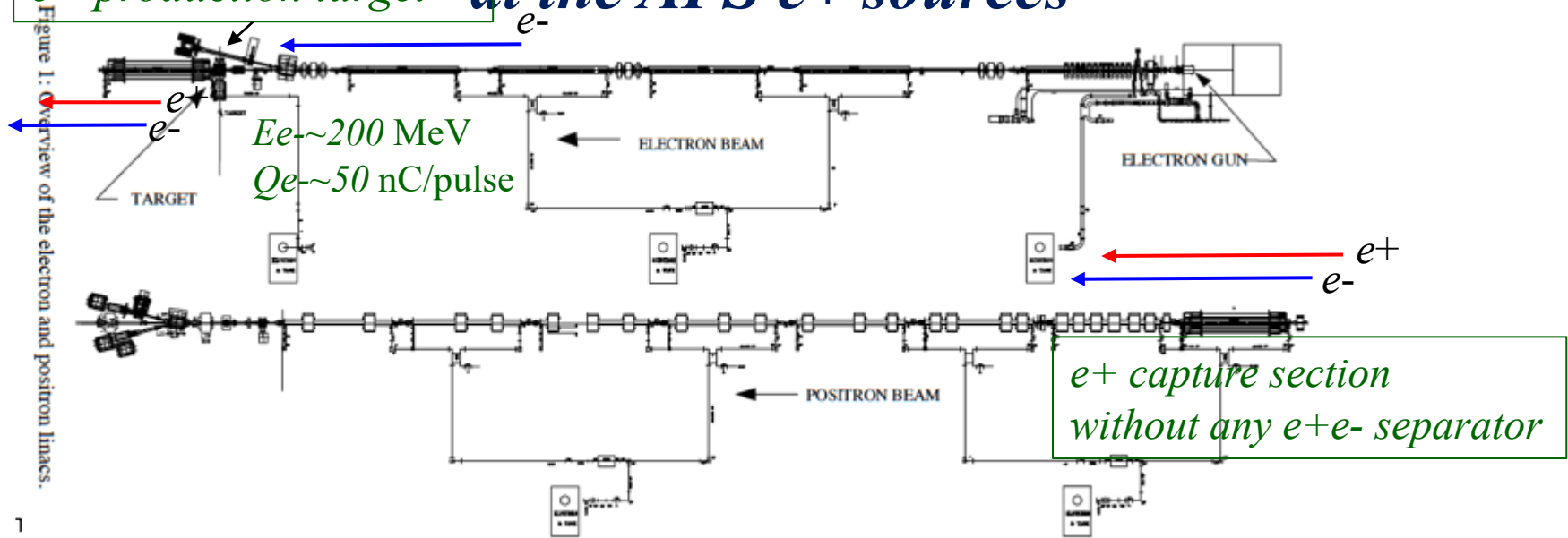

Fig. 3. BPM signal processing electronics

1. Referred by R. Fuja and Y. Chung, "APS linac beam position monitors and electronics"

2. The linac commissioning began in early October of 1993.

It is difficult to separately detect both e^- and e^+ bunch characteristics.

Conventional heterodyne technique with a fundamental 2856 MHz for e^- and e^+ 30-ns pulsed beams for a stripline bpm

Choice from the viewpoint on the pros and cons for detection techniques

To the best of my knowledge in 2018,

1. *Based on the detection technique in time domain,*

- ✓ Any high frequency signal losses for all *rf* components, transmission lines and signal pickups should be fully corrected in sufficient wide bandwidth.
- ✓ Is such a correction scheme possible in time domain?
- ✓ How much bandwidth is required at minimum?
- ✓ This technique gives a great advantage in comparison with that in frequency domain?

2. *Based on the detection technique in frequency domain,*

- ✓ any fundamental frequency is not a characteristic frequency for a single bunch,
- ✓ and a heterodyne technique is not so advantageous for a single bunch in comparison with a pulsed beam,
- ✓ and it is difficult to separately detect both *e-* and *e+* bunch characteristics.

e⁻ and e⁺ capture process in the e⁺ capture section through dynamical phase-slip process

(b) *Dynamical phase-slip process*

(upper)

e⁺ dec.
e⁻ acc.

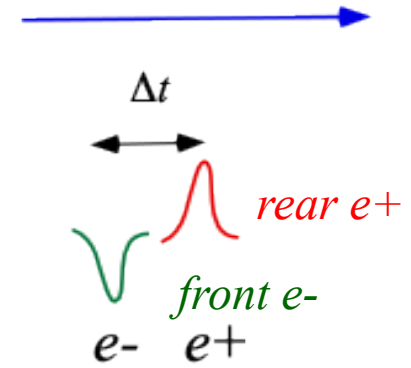
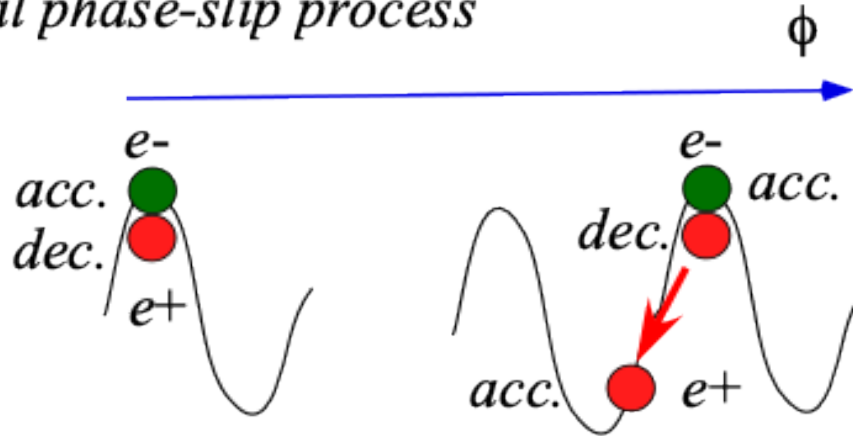

(lower)

e⁻ dec.
e⁺ acc.

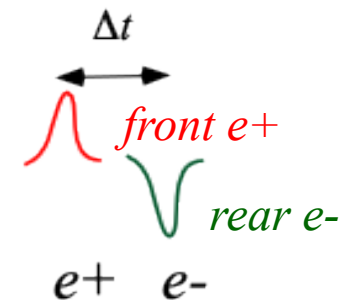
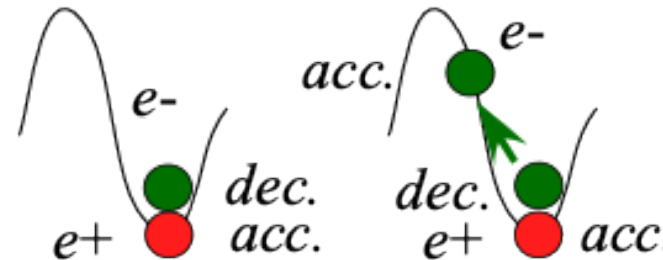

Reverse process

initial capture dynamical phase-slip process

- The line order for the e⁻ and e⁺ bunches are generated with very short time intervals ($\Delta t \sim 0 - 300$ ps) depending on the capture phase.*
- To understand the dynamical capture process, it is required to precisely measure the time interval Δt between these two bunches.*

Wideband beam monitor (WBM)

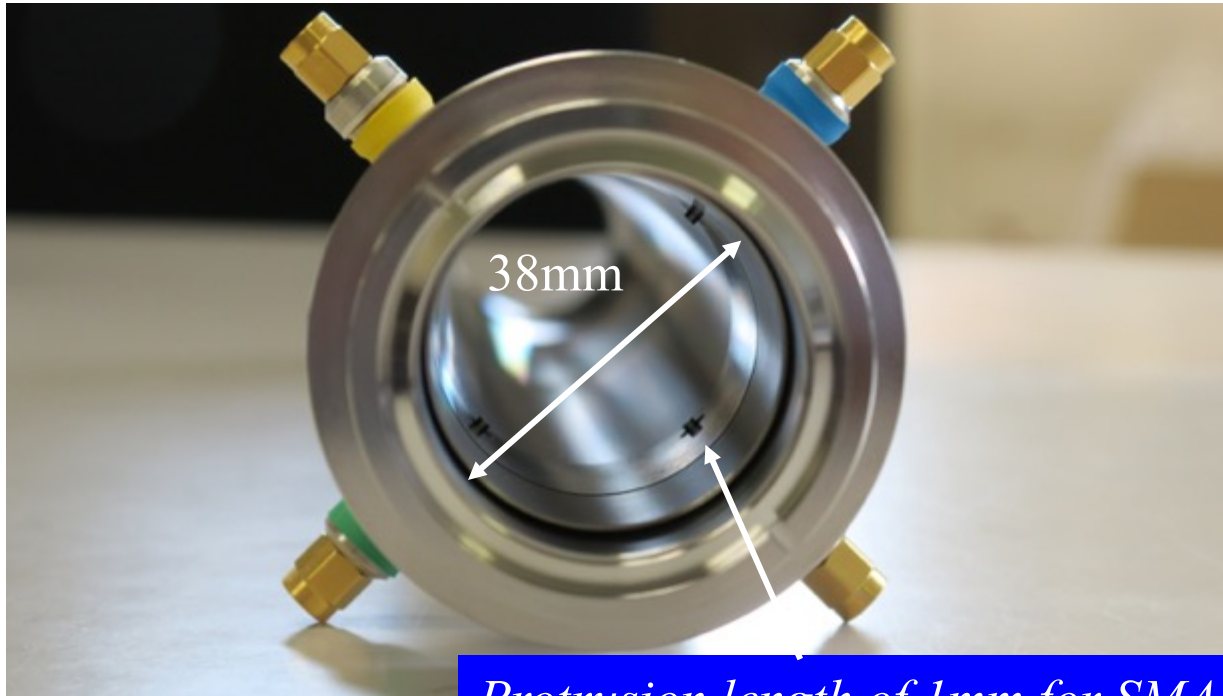

Protrusion length of 1mm for SMA feedthrough antenna from the inner surface

- ✓ Simultaneous and separate detection for both e^- and e^+ bunches is possible in time domain with any rf loss corrections for all rf components and transmission lines.*
- ✓ Fundamental bunch characteristics, bunch interval, charges, transverse positions, and bunch lengths can be separately measured for both e^- and e^+ bunches in time domain.*

Signal detection system

All rf components should be corrected in suitable frequency region by using a vector network analyzer.

✓ Coax. cables, rf combiners, and rf loss in pickups

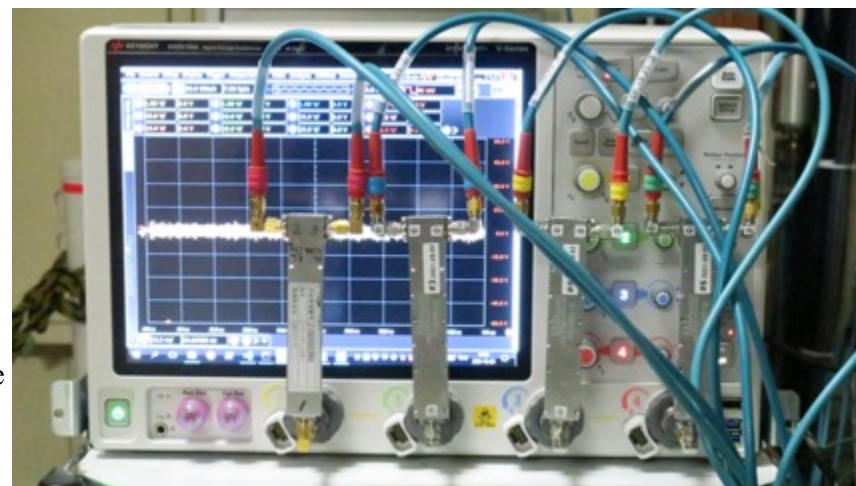

✓ Any rf signal loss corrections are available with normal and inverse FFT procedures based on “de-embedding technique”.

✓ The cut-off frequency was fixed to 9.1 GHz in the inverse FFT procedure.

✓ Any signal waveforms can be corrected in frequency domain and displayed pulse-by-pulse in time domain.

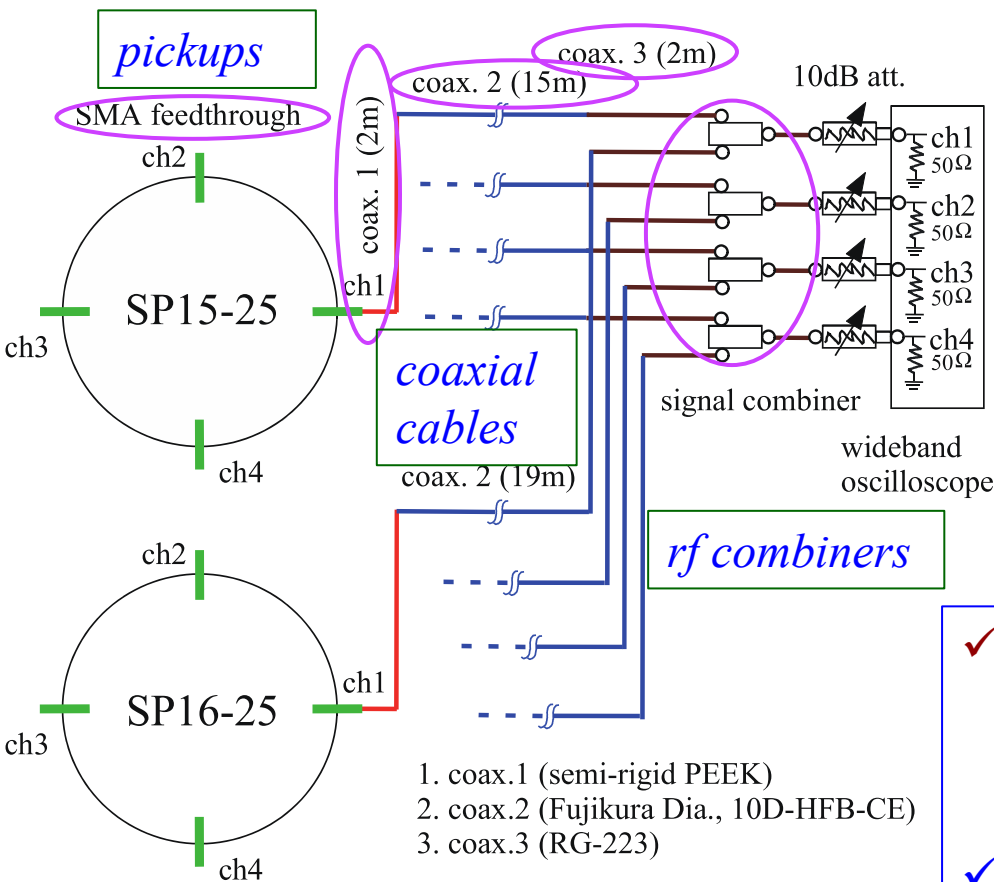

Wideband oscilloscope

✓ Keysight Tech., BW13.5GHz, 40GSa/s.

Results of the signal detection in time domain

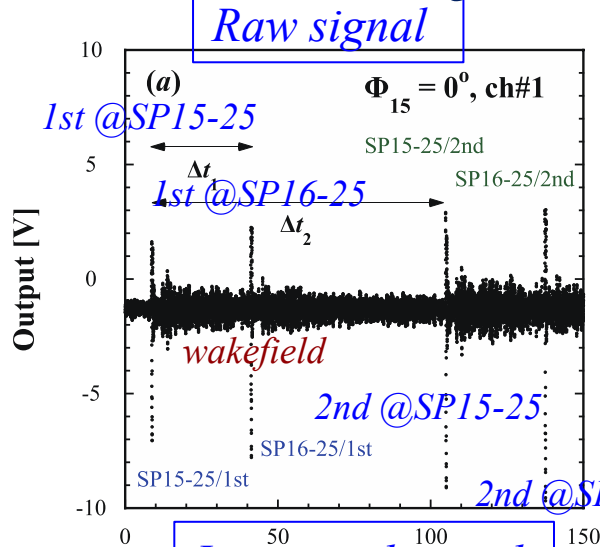

Raw signal (ch#1)

- 1) with rf-loss correction,
- 2) at $\phi_{15}=0$ deg in nominal $e+$ operation,
- 3) 2 WBM signals combined,
- 4) 2 bunch acceleration with the time interval of $\Delta t_2=96$ ns

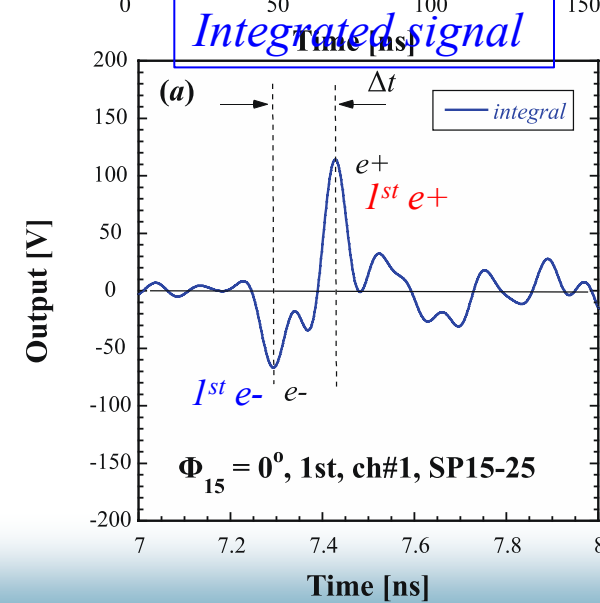
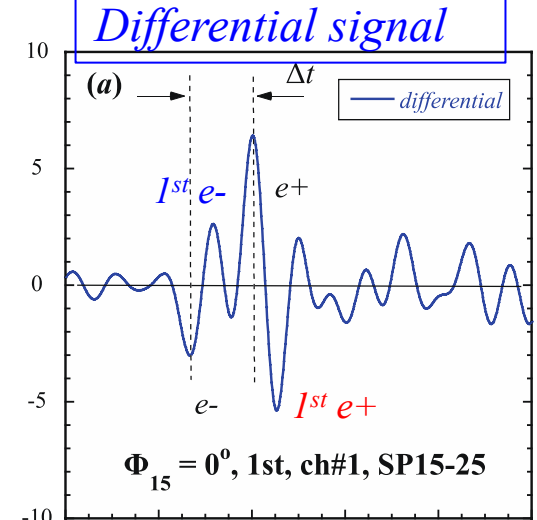

Integrated signal

for beam position calculation,
 4ch-sum Integrated signal
 for bunch length (pulse width),
 arrival timing (peak timing), and
 bunch charge (pulse area)
 calculation.

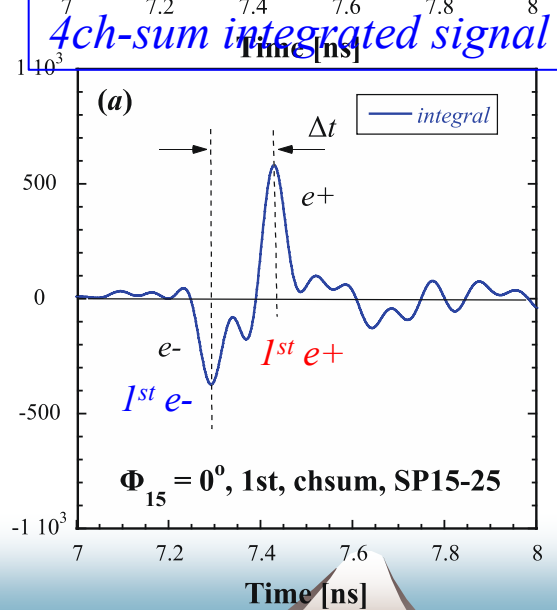

Variations during the dynamical phase-slip process for both the e^+e^- bunches depending on the capture phase

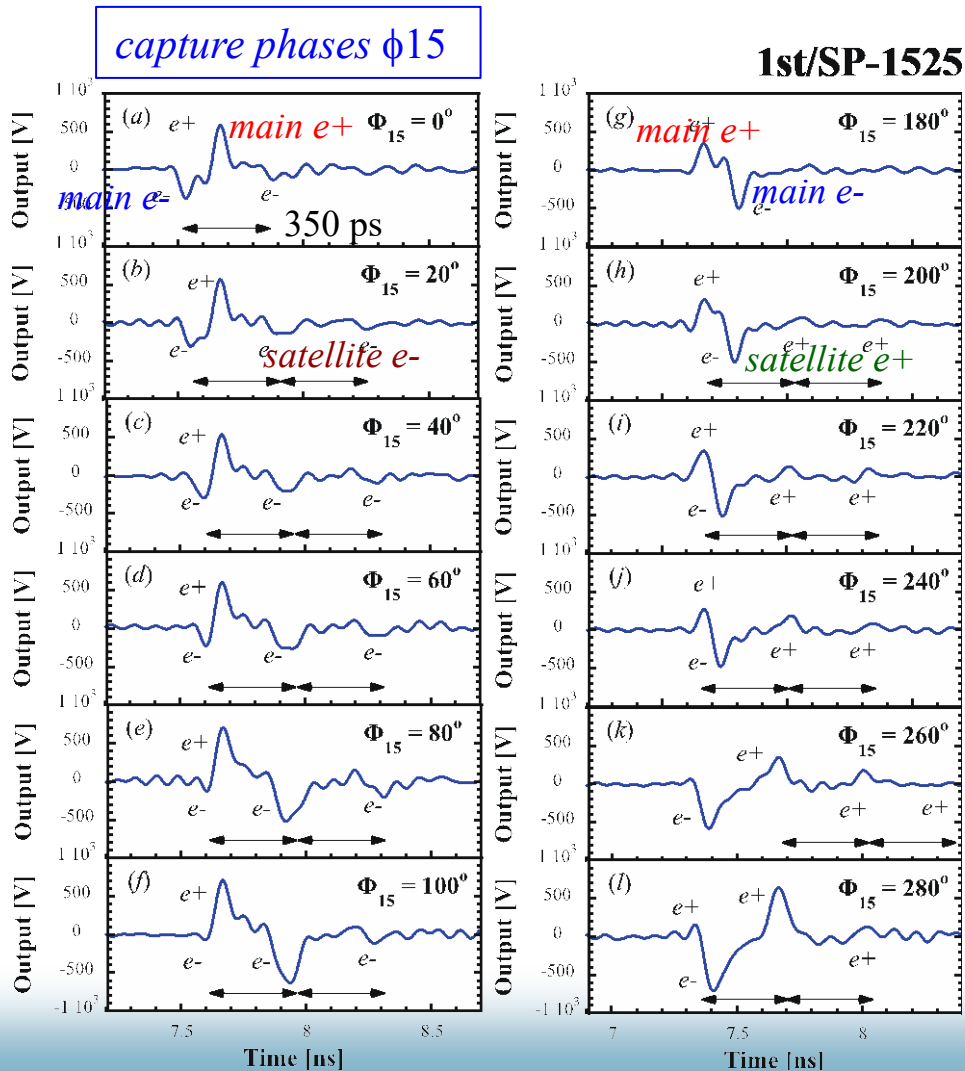

- (1) The separate detection for e^-e^+ bunches in time domain was successfully performed.
- (2) The travelling order of e^-e^+ bunches is reversed at certain capture phases through the dynamical phase-slip process.
- (3) Some satellite bunches can be identified which are 350ps apart from the main bunch. The generation of satellite bunches is caused by spill-over from the longitudinal phase space.
- (4) The results show that quite symmetric dynamical behaviors for both the bunch characteristics were observed.
- (5) The ringing waves following from the bunch signals are due to wakefields from upstream accelerator structures.

Time interval measurements for e^+e^- bunches

1st bunch@SP15-25/SP16-25

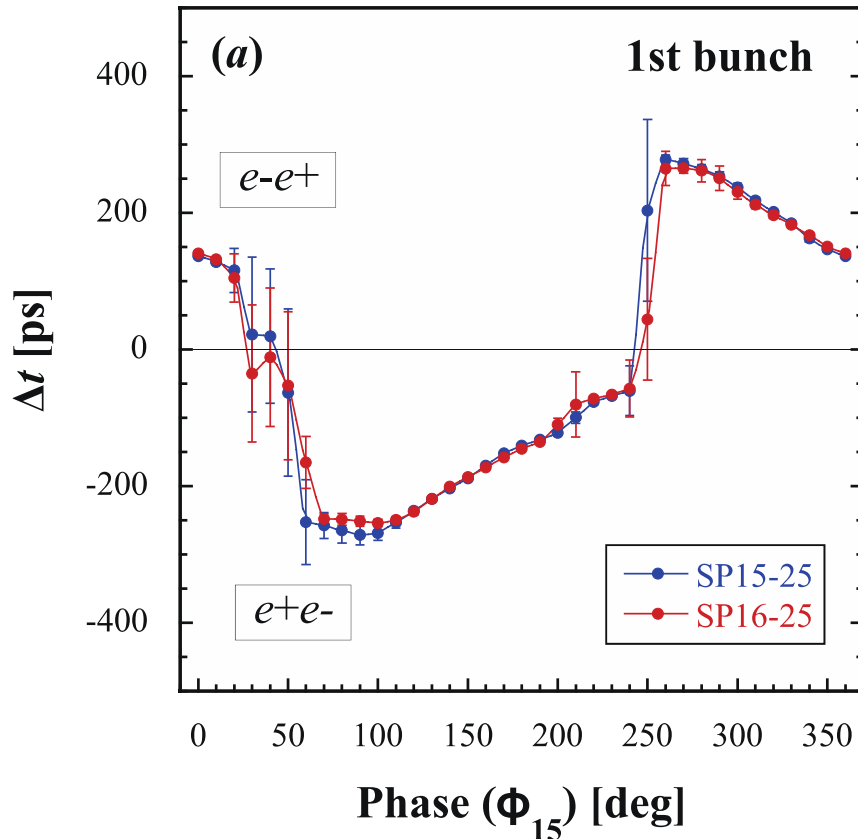

2nd bunch@SP15-25/SP16-25

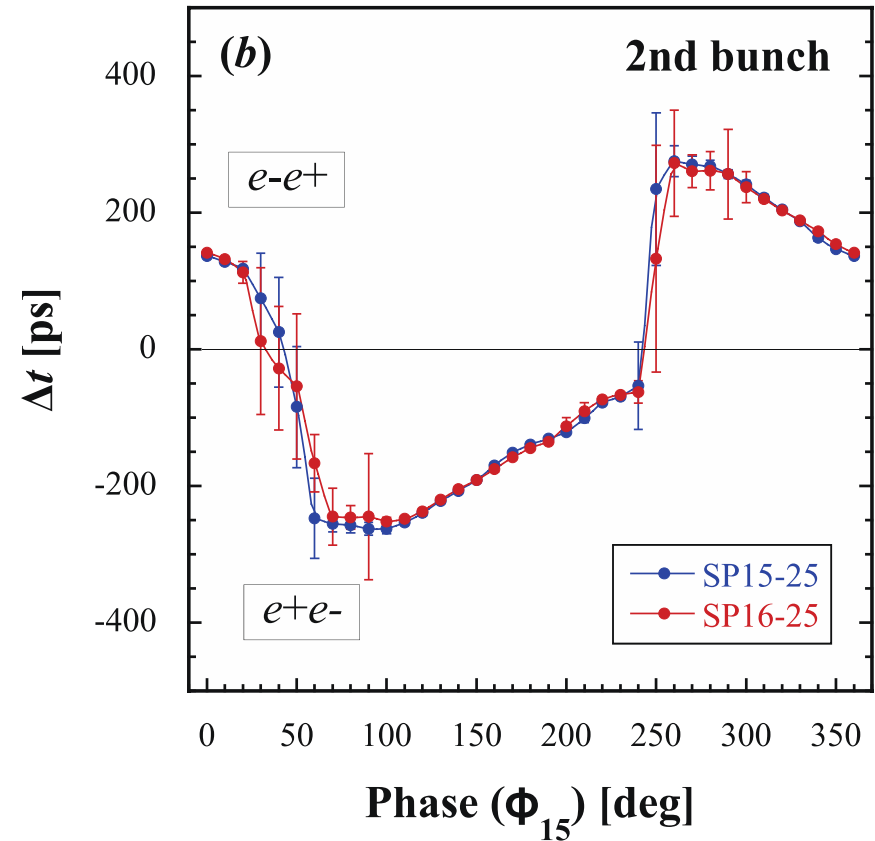

Tsuyoshi Suwada, "Direct Observation of Positron Capture Process at the Positron Source of the SuperKEKB B-Factory"; *Scientific Reports* **12**, 18554 (2022). Published online 2022 Nov. 03. <https://doi.org/10.1038/s41598-022-22030-5>.

3D plots in the bunch characteristics as functions of time interval, capture phase, and bunch intensity for e^+e^- bunches

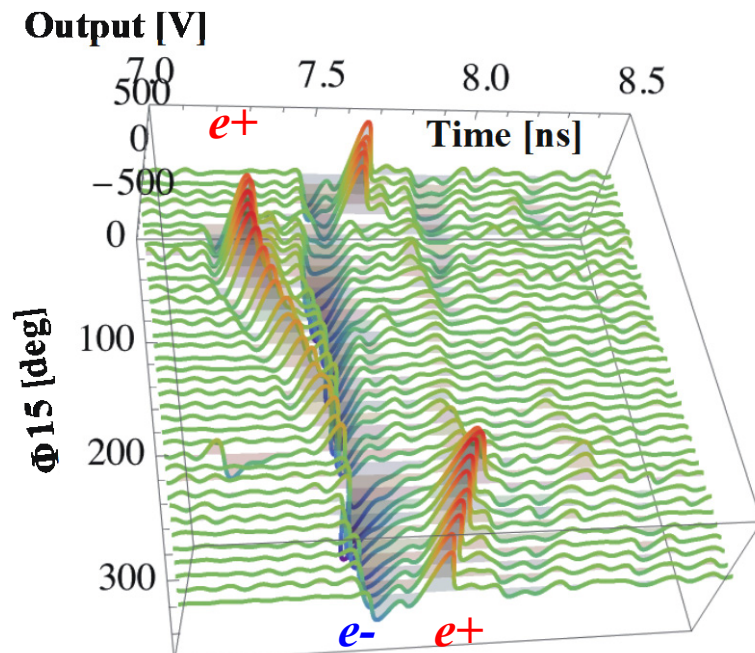

(a) 1st bunch, SP15-25

1st bunch@SP15-25/SP16-25

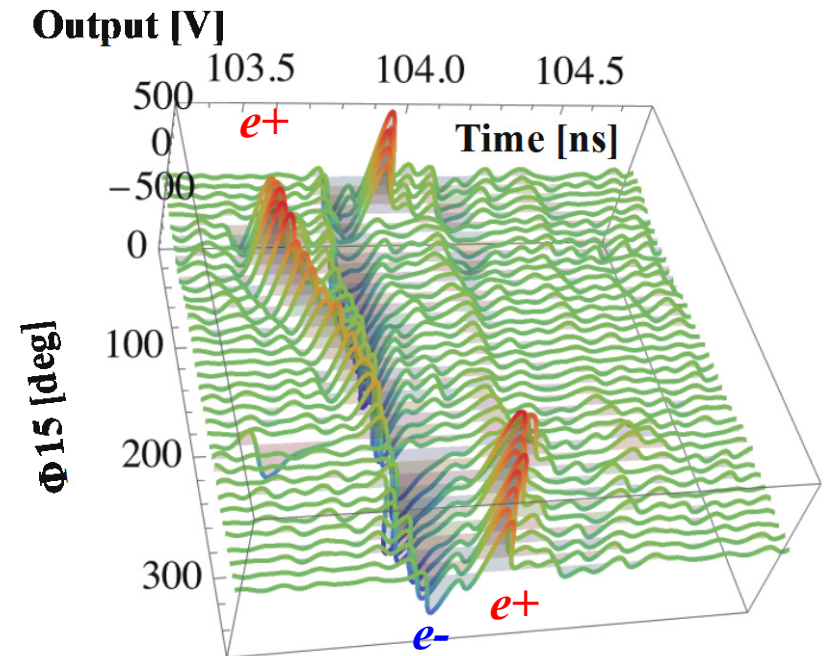

(b) 2nd bunch, SP15-25

2nd bunch@SP15-25/SP16-25

e^+e^- bunch characteristics depending on the capture phase

e^- decelerating region e^- accelerating region e^+ accelerating region e^+ decelerating region

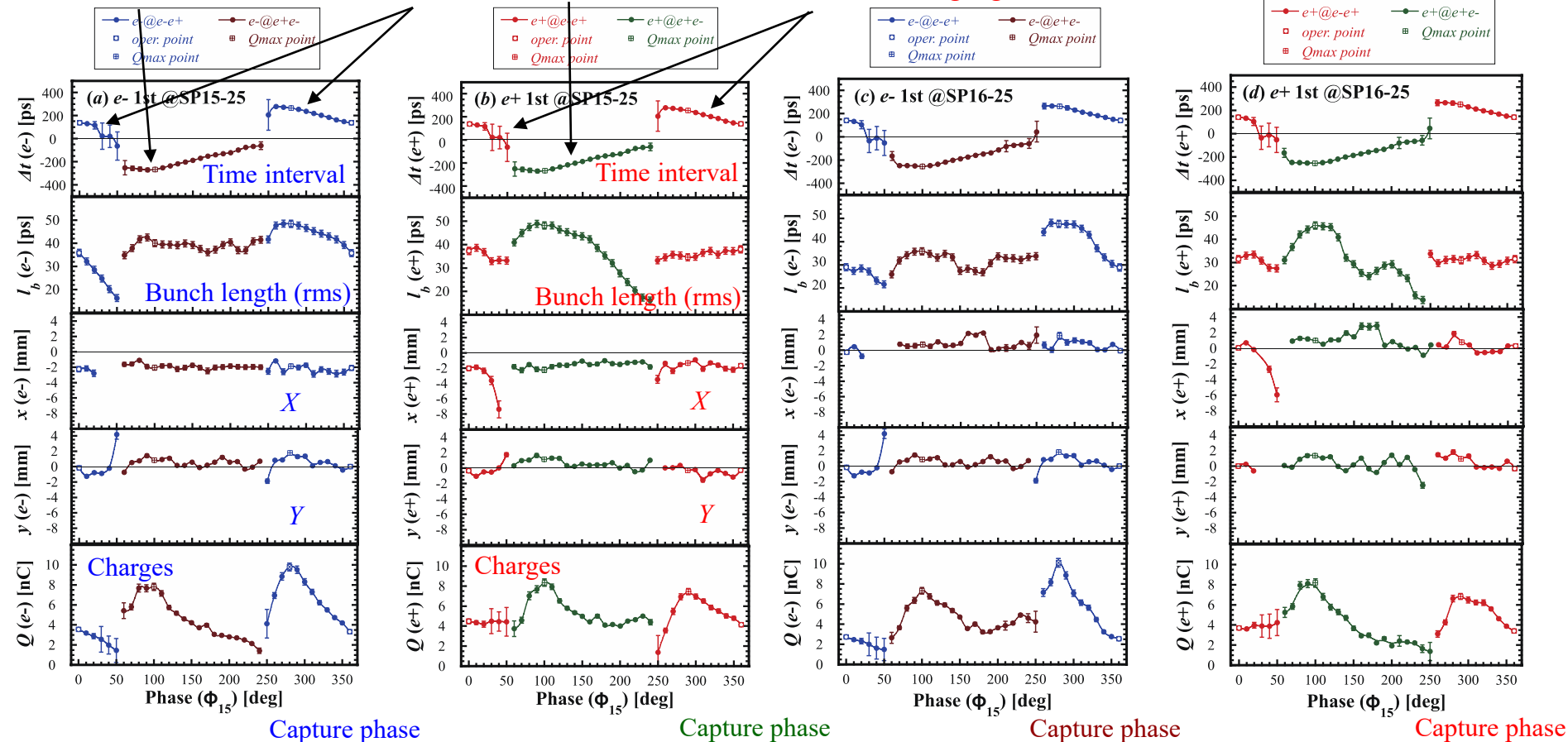

Capture phase

Capture phase

Capture phase

Capture phase

$I^{1st} e^-@e^-e^+$,
 $I^{1st} e^-@e^+e^-$ at SP15-25,
 Step phase $\Delta\phi_{15}=\Delta\phi_{16}=10^\circ$

$I^{1st} e^+@e^-e^+$,
 $I^{1st} e^+@e^+e^-$ at SP15-25

$I^{1st} e^-@e^-e^+$,
 $I^{1st} e^-@e^+e^-$ at SP16-25

$I^{1st} e^+@e^-e^+$,
 $I^{1st} e^+@e^+e^-$ at SP16-25

Plots for both the e^+e^- bunch positions at SP15-25 and SP16-25

1st e^-

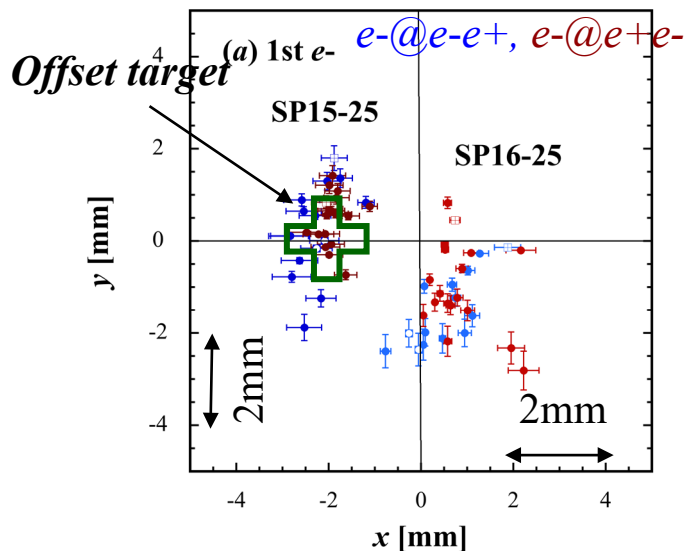
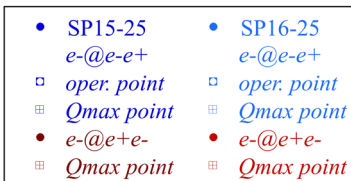

1st e^+

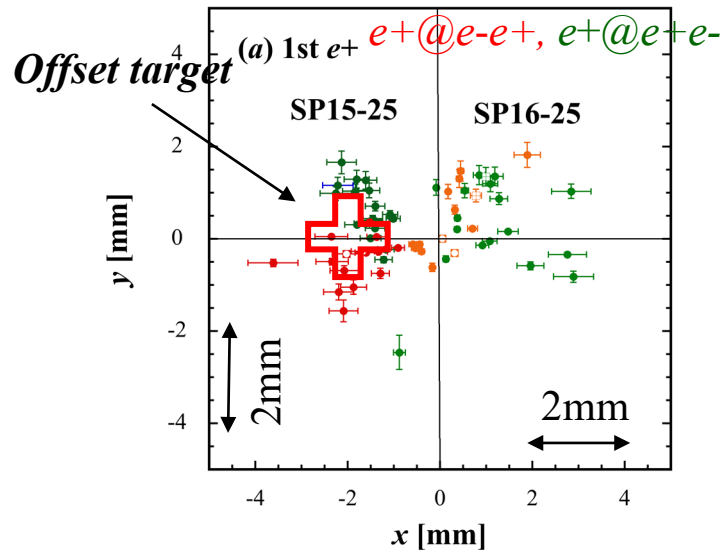
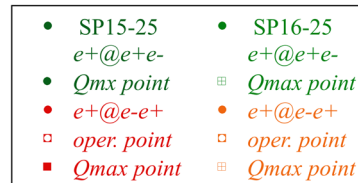

- It can be found that there are no characteristic differences in the transverse positions depending on the capture phase under the nominal operation condition and those giving the maximum charges.
- It is interesting that the cluster for each bunch rotates in the transverse plane owing to their cyclotron motion in the longitudinal direction between SP15-25 and SP16-25.

Correlation plots for the time interval and bunch charges of both e^+e^- bunches at SP15-25 and SP16-25

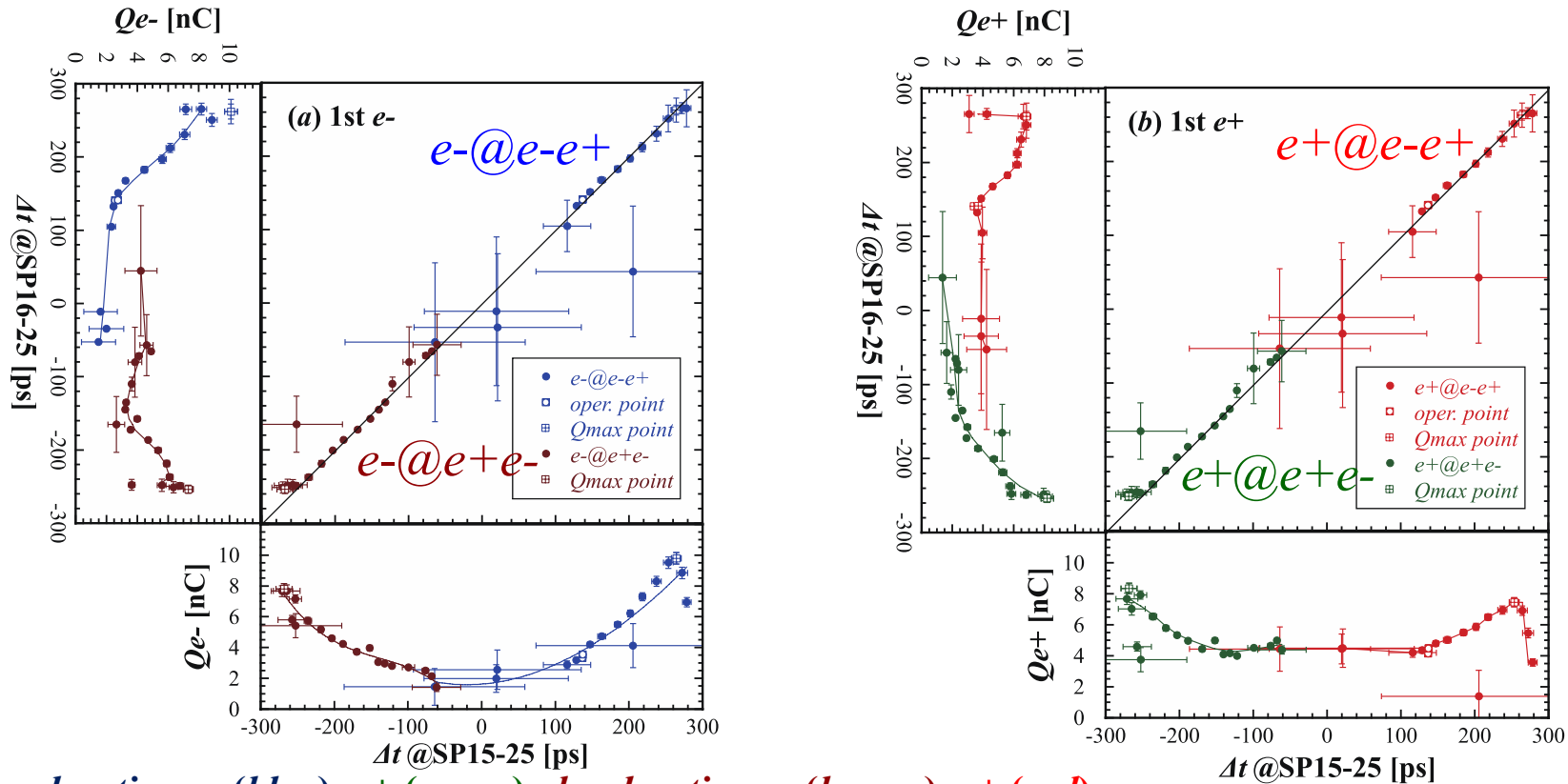

Accelerating e^- (blue), e^+ (green), decelerating e^- (brown), e^+ (red)

- The time interval correlation is based on a 45° inclined line.
- This result means that the dynamical phase slip process was completed at the first WBM (SP15-25).
- The maximum charges are generated at the maximum time intervals even for the different bunches, $\Delta t \sim 268$ ps ($\Delta t \sim 268$ ps)@ acc. e^- (acc. e^+), $\Delta t \sim 264$ ps ($\Delta t \sim 253$ ps)@ dec. e^- (dec. e^+), respectively.

Correlation plots for the bunch length and bunch charges of both e^+e^- bunches at SP15-25 and SP16-25

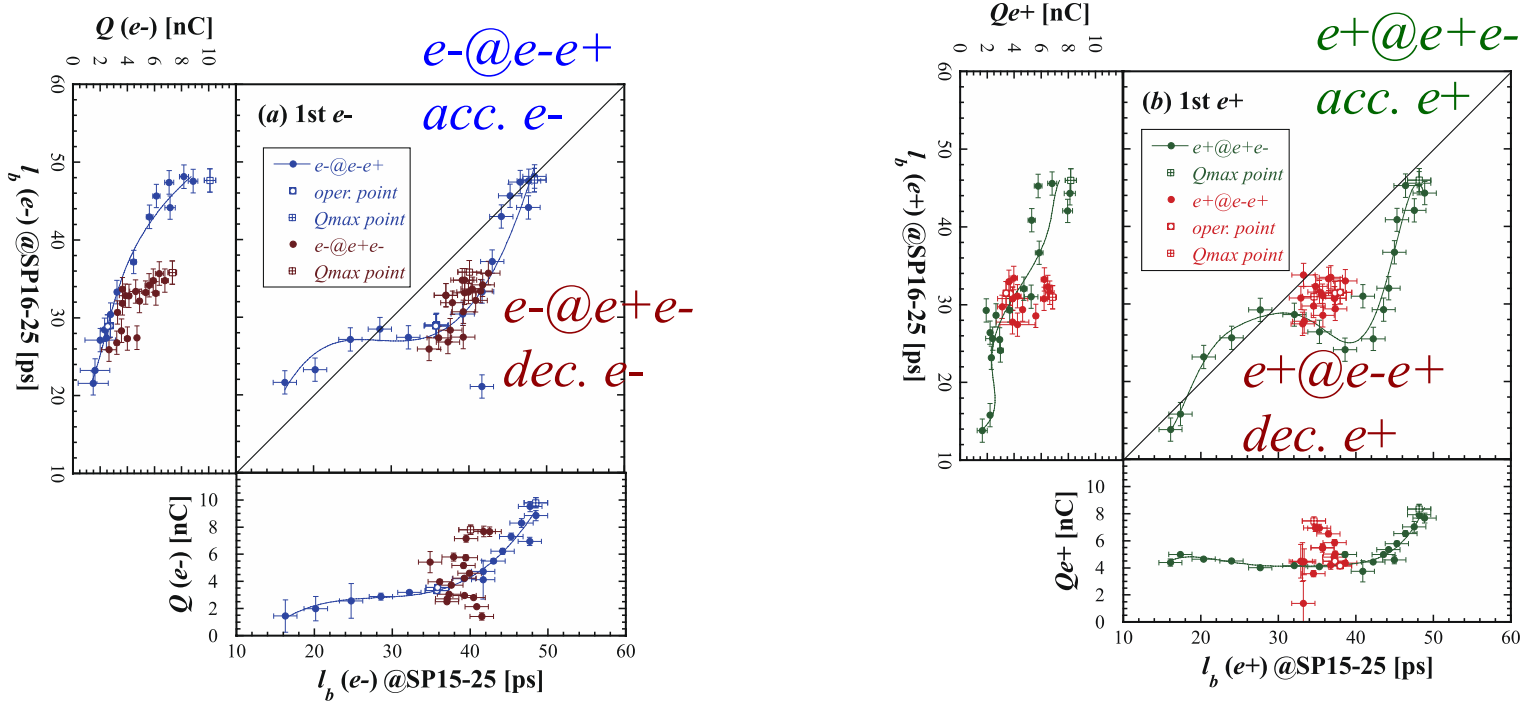

- Although the dynamical phase-slip process was fixed at the front WBM (SP15-25), the dynamical exchange of particles in the longitudinal direction inside the bunch may be caused, called bunch lengthening (or shortening).
- The correlation seems to be based on a 3rd-order polynomial function in the accelerating phase region, and on the other hand, that shows a bunch shortening in the decelerating phase region.
- The maximum bunch charges are generated at the maximum bunch length.

Variations in e^+e^- bunch charges as a function of the capture phase at SP15-25 and SP16-25

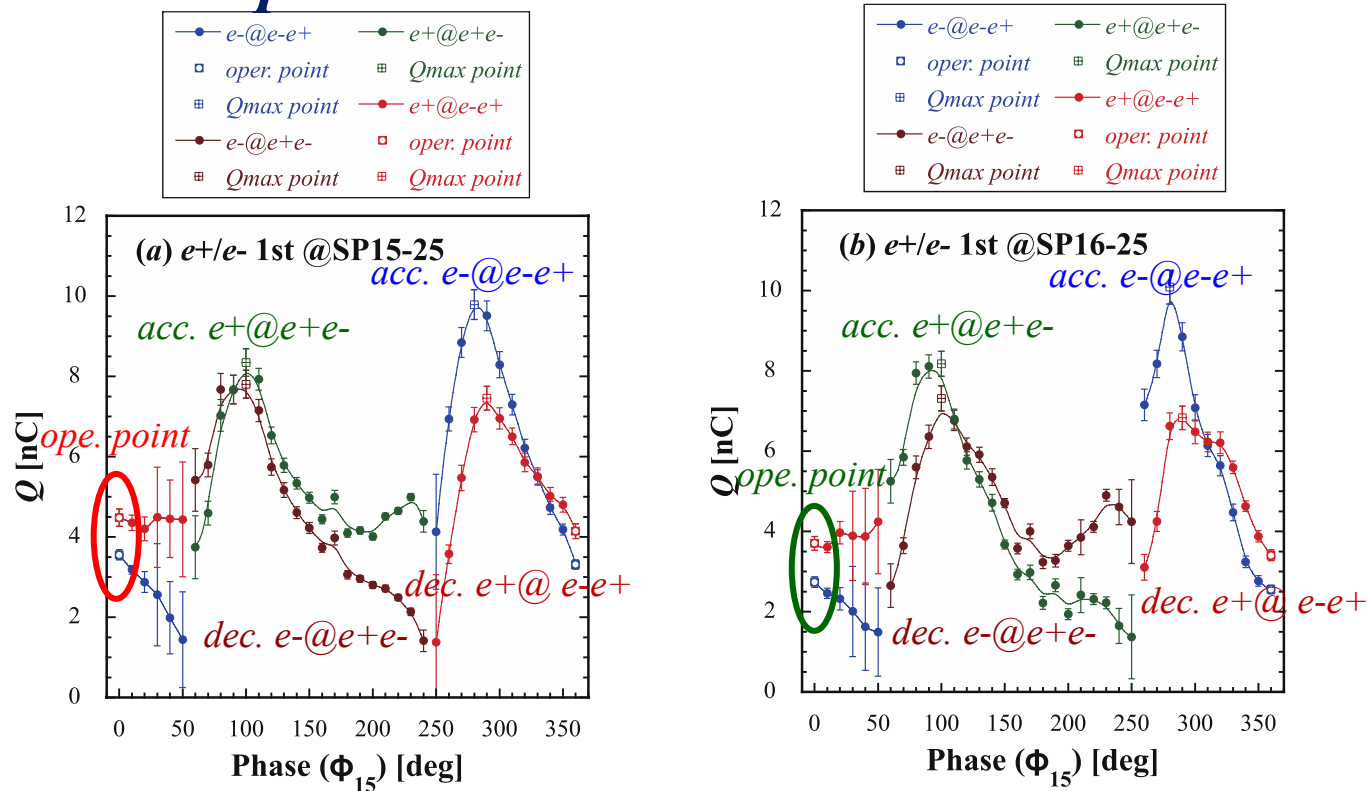

- The present operation point is not on an optimized point.
- The e^+e^- bunch charges in the accelerating phase region are greater than those in the decelerating phase region in the capture section.
- The e^+ yields at the peak points in the acc. and dec. phase regions are 122% and 84% greater than that at the nominal operation e^-e^+ point, respectively.

Variations in the e^+ bunch charges as a function of the capture phase at SP15-25, SP16-25, and SP16-5

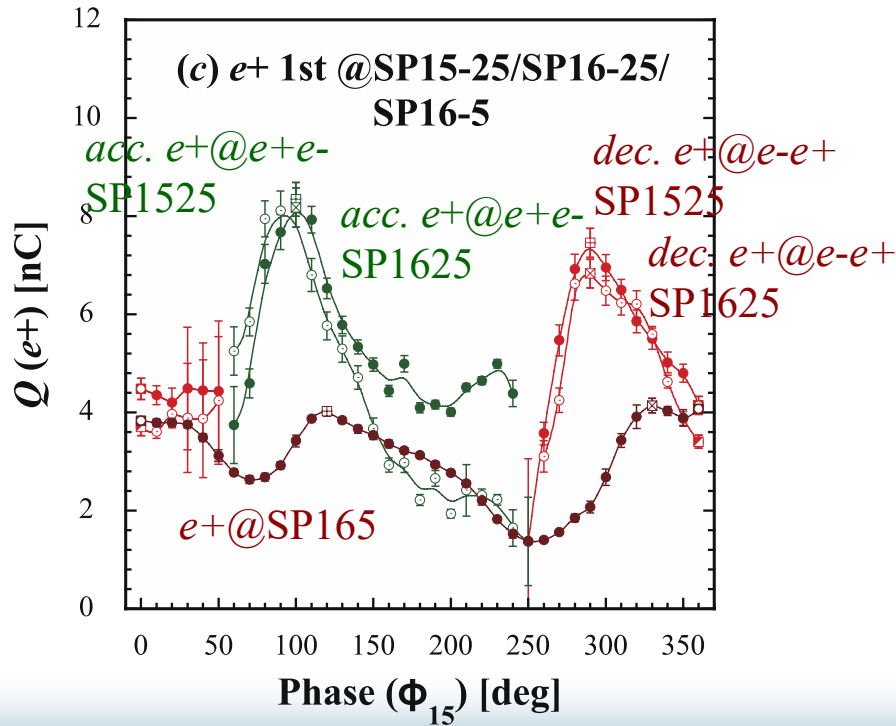
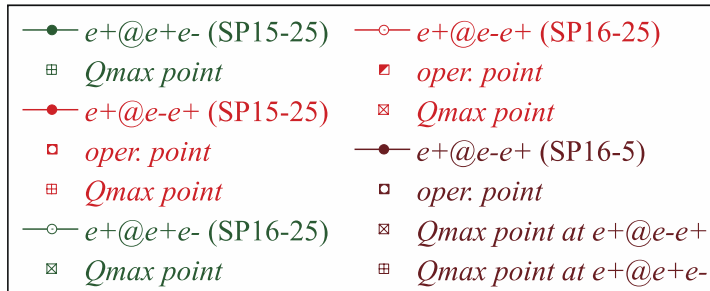

- It is clear that the present operation point is not on an optimized point.
- The e^+ yield at the maximum point obtained by a BPM after the capture section is only $\sim 5\%$ greater than that at the nominal operation point.
- The capture phase at the max. e^+ yield in the capture section is shifted from that after the capture section.
- The results show that only the e^+ yield measurement at the location after the capture section is not sufficient in the optimization procedure. More detailed parameter tunings may be required.

Conclusions

- Direct simultaneous measurements of the secondary e^+e^- bunch characteristics were successfully performed with WBMs at the e^+ source of the SuperKEKB B-factory.
- Longitudinal and transverse bunch characteristics were obtained for each bunch as a function of the capture phase to investigate their dynamical capture process under two-bunch acceleration scheme.
- The results show that quite symmetric behaviors in the e^-e^+ bunch characteristics were observed.
- Such wideband detection techniques could be applied to conventional and advanced e^+ sources in future accelerator projects.
- The obtained results may improve simulations in any e^+ capture sections, and the e^+ intensity can be systematically optimized in multidimensional parameter spaces toward high-intensity e^+ sources.

References

1. Tsuyoshi Suwada, Muhammad Abdul Rehman, and Fusashi Miyahara, “First simultaneous detection of electron and positron bunches at the positron capture section of the SuperKEKB factory”; *Scientific Reports* **11**, 12751 (2021). <https://doi.org/10.1038/s41598-021-91707-0>.
2. Tsuyoshi Suwada, “Modal Analysis of Electromagnetic Couplings between SMA-Feedthrough Electrode and Beam for Wideband Beam Monitor”; Poster presented at *the 10th International Beam Instrumentation Conference (IBIC2021)*, Video meeting hosted by PAL, Korea, Sep. 13-16, 2021, pp. 392-395 (JACoW Publishing, 2021) [ISBN 978-3-95450-230-1, doi:10.18429/JACoW-IBIC2021-WEPP12].
3. M. A. Rehman and T. Suwada, “Observation of Wakefield Effects with Wideband Feedthrough-BPM at the Positron Capture Section of the SuperKEKB Injector Linac”; *Proceedings of the 10th International Beam Instrumentation Conference (IBIC2021)*, Pohang, Rep. of Korea, Sep. 13-16, 2021, pp. 52-55 (JACoW Publishing, 2021) [ISBN 978-3-95450-230-1, doi:10.18429/JACoW-IBIC2021-MOPP10].
4. M.A. Rehman, T. Suwada, and M. Miyahara; “First synchronous measurement of single-bunched electron and positron beams with a wideband feedthrough-BPM at the positron capture section of the SuperKEKB injector linac”; *Proceedings of the 2021 Particle Accelerator Conference (IPAC'21)*, hosted by the Brazilian Center for Research in Energy and Materials (CNPEM), Campinas, Brazil, May 24-28, 2021, pp.557-560 (MOPAB163); ISBN: 978-3-95450-214-1, ISSN: 2673-5490, doi:10.18429/JACoW-IPAC2021-MOPAB163.
5. T. Suwada, “Characteristic Analysis of Wideband Beam Monitor with High Frequency Pickups”; *Rev. Sci. Instrum.* **93**, 093301 (2022) [DOI: 10.1063/5.0087321].
6. Tsuyoshi Suwada, “Direct Observation of Positron Capture Process at the Positron Source of the SuperKEKB B-Factory”; *Scientific Reports* **12**, 18554 (2022). Published online 2022 Nov. 03. <https://doi.org/10.1038/s41598-022-22030-5>.
7. T. Suwada, “First direct measurement of electron and positron bunch characteristics at the positron source of the SuperKEKB B-Factory”; *AIP Advances* **13**, 045021 (2023); [DOI: 10.1063/5.0145776].